

# SELNOVA PRO









# SELNOVA PRO

selnova è una collezione di successo. la sua linea elegantemente sobria, la praticità e l'equilibrato rapporto tra forma e funzione ne hanno decretato un riconoscimento che dura nel tempo, al pari della qualità delle ceramiche Pozzi-Ginori. rinnovarla ottimizzando le sue caratteristiche di comfort e di universale adattabilità, per noi significa non accontentarsi del risultato ma puntare al meglio. un disegno dalle linee più fluide con bordi assottigliati valorizza il profilo estetico degli elementi. migliorate caratteristiche funzionali dei vasi assicurano un significativo risparmio d'acqua. lavabi di diverse dimensioni e un lavamani, coppie di sanitari proposti in tre differenti tipologie di installazione: tradizionale, a filo parete e sospesa. per un bagno caratterizzato da praticità e utilizzo razionale degli spazi. è quanto abbiamo realizzato con SELNOVA PRO. un best seller nel bagno.

selnova is a highly successful collection. its elegantly sober silhouette, practicality and fine balance of form and function have ensured its popularity has been longlasting, just like the quality of Pozzi Ginori sanitaryware. we are now updating the collection, optimising its positive characteristics and universal adaptability, a sign that we do not content ourselves with past results but aim for the best. a design with more fluid lines and narrower rims enhances the look of the pieces. the toilets' improved functional characteristics enable significant water savings. washbasins in various sizes and a hand washbasin, toilets and bidets available in three different installation types: classic, back-to-wall and wall-hung. for a bathroom made to be practical and with a rational use of the space. this is what we have achieved with SELNOVA PRO. a bathroom bestseller.











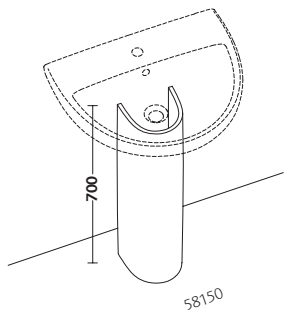
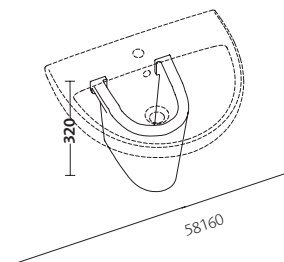
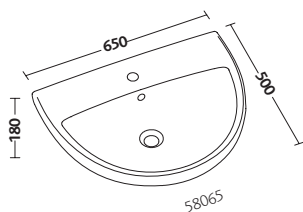
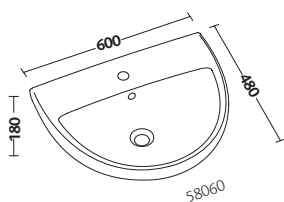
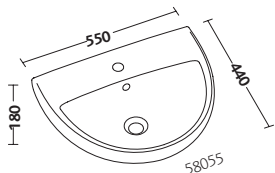
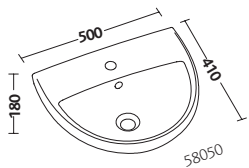
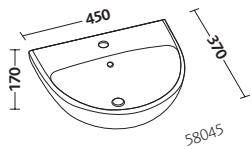

specchio raggio 60x65 (36805)  
lavabo 60 (58060)  
colonna (58150)

pagine precedenti  
specchio raggio 60x65 (36805)  
lavabo 65 (58065)  
sifone Geberit cromato per lavabo (151.035.21.1)  
vaso sospeso (58010)  
bidet sospeso (58011)  
placca di comando Geberit Sigma 30  
doppio tasto cromato/satinato/cromato  
(115.883.KN.1)  
piatto doccia 60mm 120x80 (60042)  
sifone doccia Geberit d90 (150.552.21.1)

specchi raggio 60x65 (36805)  
lavabi 55 (58055)  
semicolonna (58160)

mirror raggio 60x65 (36805)  
washbasin 60 (58060)  
pedestal (58150)

previous pages  
mirror raggio 60x65 (36805)  
washbasin 65 (58065)  
bright chrome plated trap Geberit for washbasin  
(151.035.21.1)  
wall hung water closet (58010)  
wall hung bidet (58011)  
chrome/brushed/chrome actuator plate  
Geberit Sigma 30 double button (115.883.KN.1)  
shower trays 60mm 120x80 (60042)  
shower drain Geberit d90 (150.552.21.1)

mirrors raggio 60x65 (36805)  
washbasins 55 (58055)  
semi-pedestal (58160)















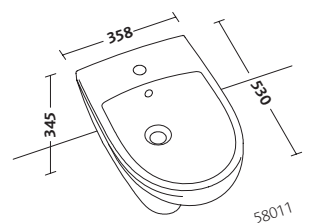
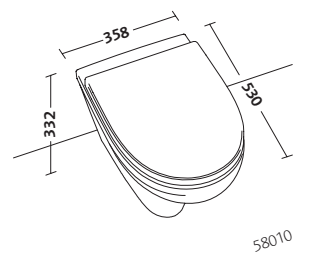
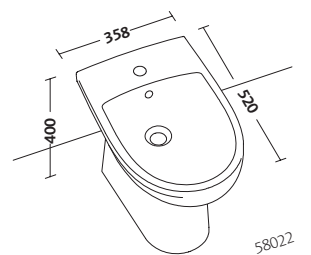
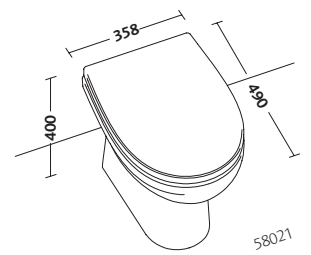
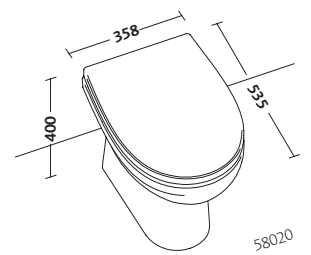
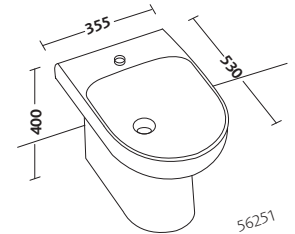
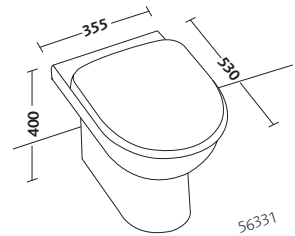

vaso (58020)  
bidet (58022)  
placca di comando Geberit Sigma 20  
bianco/cromato/bianco (115.882.KJ.1)

pagine precedenti  
specchio raggio 120x65 (36808)  
lavabo sopra piano da incasso ovale variform (500.720.01.3)  
vaso filo parete (56331)  
bidet filo parete (56251)  
placca di comando Geberit Sigma 30  
doppio tasto cromato/satinato/cromato (115.883.KN.1)

water closet (58020)  
bidet (58022)  
white/chrome/white actuator plate  
Geberit Sigma 20 (115.882.KJ.1)

previous pages  
mirror raggio 120x65 (36808)  
in-set countertop washbasin oval variform (500.720.01.3)  
back to wall water closet (56331)  
back to wall bidet (56251)  
chrome/brushed/chrome actuator plate  
Geberit Sigma 30 double button (115.883.KN.1)





vaso sospeso (58010)  
bidet sospeso (58011)  
placca di comando Geberit  
Sigma 20  
satinato/cromato/satinato (115.882.KN.1)  
piatto doccia seventy 120x80 (60188)  
sifone doccia Geberit d90 (150.552.21.1)

wall hung water closet (58010)  
wall hung bidet (58011)  
brushed/chrome/brushed actuator plate  
Geberit Sigma 20 (115.882.KN.1)  
shower trays seventy 120x80 (60188)  
shower drain Geberit d90 (150.552.21.1)

vaso sospeso (58010)  
bidet sospeso (58011)  
placca di comando Geberit Sigma 20  
satinato/cromato/satinato (115.882.KN.1)

wall hung water closet (58010)  
wall hung bidet (58011)  
actuator plate Geberit Sigma 20 (115.882.KN.1)







# SELNOVA PRO

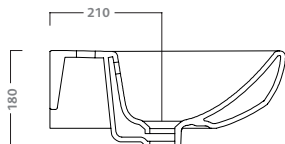
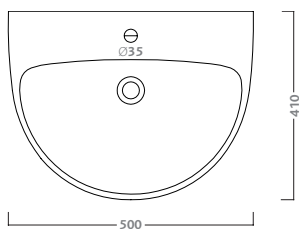

## lavabo 50

disponibile per rubinetteria monoforo e a tre fori (foro centrale aperto e due fori laterali a frattura prestabilita).  
peso kg ca. 11

codice	descrizione
58050	lavabo 50

## washbasin 50

available with one or three tap-holes (central tap-hole fully punched, other two tap-holes semi-punched).  
weight 11 kg

code	description
58050	washbasin 50

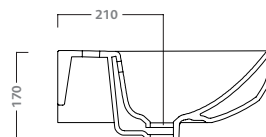
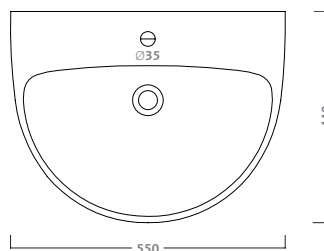

## lavabo 55

disponibile per rubinetteria monoforo e a tre fori (foro centrale aperto e due fori laterali a frattura prestabilita).  
peso kg ca. 12.7

codice	descrizione
58055	lavabo 55

## washbasin 55

available with one or three tap-holes (central tap-hole fully punched, other two tap-holes semi-punched).  
weight 12.7 kg

code	description
58055	washbasin 55





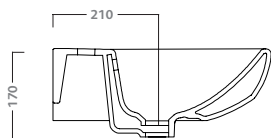
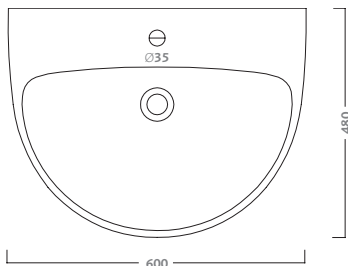

#### lavabo 60

disponibile per rubinetteria monoforo e a tre fori (foro centrale aperto e due fori laterali a frattura prestabilita).  
peso kg ca. 13.8

codice	descrizione
58060	lavabo 60

#### washbasin 60

available with one or three tap-holes (central tap-hole fully punched, other two tap-holes semi-punched).  
weight 13.8 kg

code	description
58060	washbasin 60

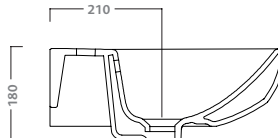
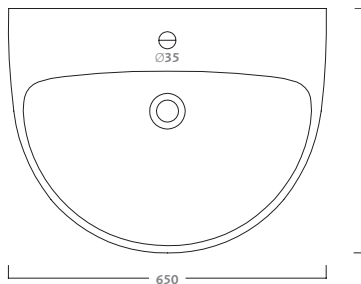

#### lavabo 65

disponibile per rubinetteria monoforo e a tre fori (foro centrale aperto e due fori laterali a frattura prestabilita).  
peso kg ca. 14

codice	descrizione
58065	lavabo 65

#### washbasin 65

available with one or three tap-holes (central tap-hole fully punched, other two tap-holes semi-punched).  
weight 14 kg

code	description
58065	washbasin 65



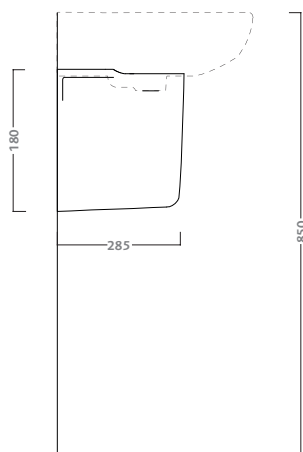

### semicolonna

da abbinare a lavabo 50 cod. 58050,  
lavabo 55 cod. 58055, lavabo 60 cod.  
58060, lavabo 65 cod. 58065.  
peso kg ca. 9

codice	descrizione
58160	semicolonna

### semi-pedestal

can be combined with washbasin 50  
cod. 58050, washbasin 55 cod. 58055,  
washbasin 60 cod. 58060,  
washbasin 65 cod. 58065.  
weight 9 kg

code	description
58160	semi-pedestal

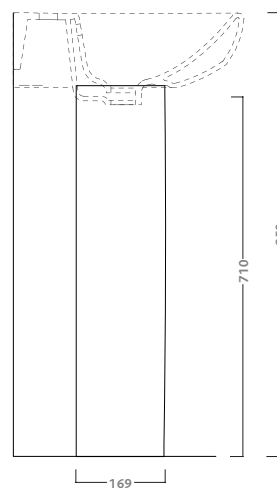

### colonna

da abbinare a lavabo 50 cod. 58050,  
lavabo 55 cod. 58055, lavabo 60 cod.  
58060, lavabo 65 cod. 58065.  
peso kg ca. 9.4

codice	descrizione
58150	colonna

### pedestal

can be combined with washbasin 50  
cod. 58050, washbasin 55 cod. 58055,  
washbasin 60 cod. 58060, washbasin  
65 cod. 58065.  
weight 9.4 kg

code	description
58150	pedestal



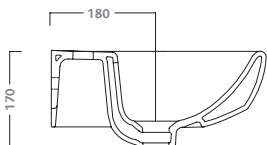
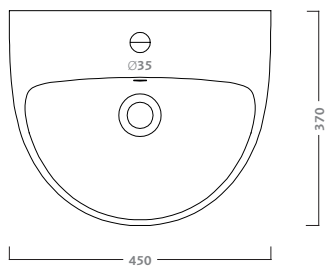

**lavamani**  
disponibile per rubinetteria monoforo.  
peso kg ca. 9

codice	descrizione
58045	lavamani

**hand washbasin**  
available with one tap-holes.  
weight 9 kg

code	description
58045	hand washbasin



# SELNOVA PRO

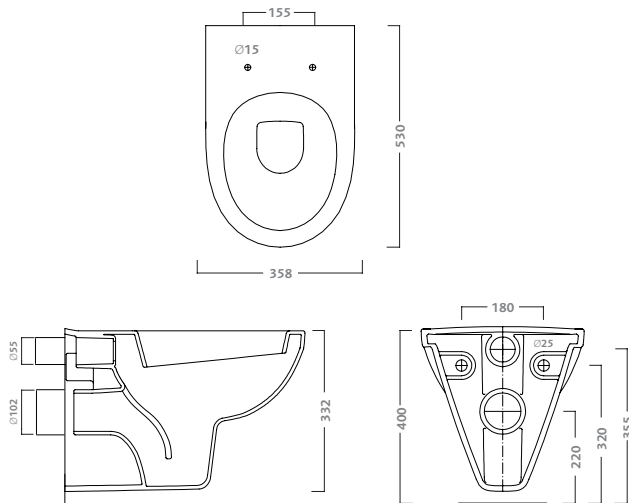

## vaso sospeso

vaso a cacciata con scarico a parete (P). funziona con 4 litri.  
peso kg ca. 17

codice	descrizione
58010	vaso sospeso
56764	sedile in termoindurente con cerniere in plastica
56763	sedile in termoindurente con cerniere cromate
56762	sedile in termoindurente con chiusura ammortizzata
110.790.00.1	Geberit Combifix Italia Sigma8 per vaso sospeso, 109 cm
111.795.00.1	Geberit Duofix Italia Sigma8 per vaso sospeso, 114 cm

## wall hung water closet

horizontal (H) outlet washdown bowl. 4 liters flushing.  
weight 17 kg

code	description
58010	wall hung water closet
56764	duroplast seat with plastic hinges
56763	duroplast seat with chrome-plated hinges
56762	duroplast seat with soft close mechanism
110.790.00.1	Geberit Combifix Italia Sigma8 for wall hung water closet, 109 cm
111.795.00.1	Geberit Duofix Italia Sigma8 for wall hung water closet, 114 cm



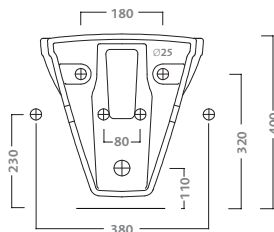
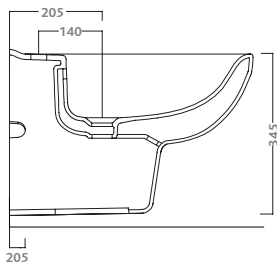
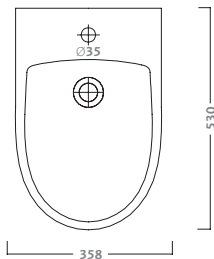

#### **bidet sospeso**

disponibile per rubinetteria monoforo.  
per allacciamento acqua esterno ed interno.  
peso kg ca. 16.1

codice	descrizione
58011	bidet sospeso
457.608.00.5	Geberit Combifix Italia per bidet sospeso.
111.512.00.1	Geberit Duofix per bidet sospeso altezza parziale 112 cm

#### **wall hung bidet**

available for one tap-hole. for hidden and external water connectio. weight 16.1 kg

code	description
58011	wall hung bidet
457.608.00.5	Geberit Combifix Italia for wall hung bidet.
111.512.00.1	Geberit Duofix for wall hung bidet with partial height 112 cm



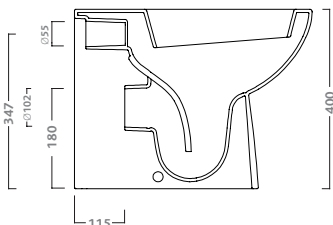
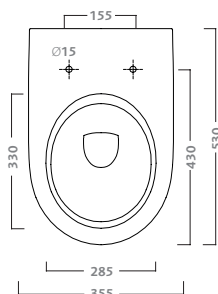

## vaso

vaso a cacciata con scarico multi (S/P).

per installazione filo parete. funziona con 4 litri. peso kg ca. 25

codice	descrizione
56331	vaso per installazione filo parete
56764	sedile in termoindurente con cerniere in plastica
56763	sedile in termoindurente con cerniere cromate
56762	sedile in termoindurente con chiusura ammortizzata
41962	curva per vaso con scarico a pavimento
131.081.11.1	curva P per scarico a pavimento
131.015.11.1	curva 90 per scarico a pavimento
41963	manicotto per vaso a pavimento con scarico a parete
152.613.11.1	manicotto per vaso a pavimento con scarico a parete 110 mm

## water closet

multi outlet (V/H) washdown bowl. for back to wall installation. 4 liters flushing. weight 25 kg

code	description
56331	back to wall installation water coset
56764	duroplast seat with plastic hinges
56763	duroplast seat with chrome-plated hinges
56762	pipe for floorstanding water closet with vertical outlet
41962	pipe for floorstanding water closet with vertical outlet
131.081.11.1	pipe P for floorstanding water closet with vertical outlet.
131.015.11.1	pipe 90 for floorstanding water closet with vertical outlet
41963	socket for floorstanding water closet with horizontal outlet
152.613.11.1	socket for floorstanding water closet with horizontal outlet 110 mmm

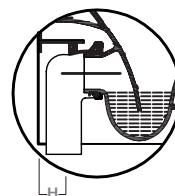

con curva 131.015.11.1  
with outlet 131.015.11.1  
H min 60  
H max 105



con curva 131.081.11.1  
with outlet 131.081.11.1  
H min 155  
H max 170

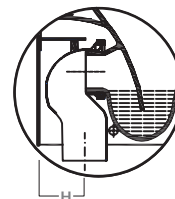

con curva 41962  
with outlet 41962  
H min 100  
H max 120

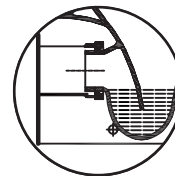

con curva 41963  
with outlet 41963  
con curva 152.613.11.1  
with outlet 152.613.11.1



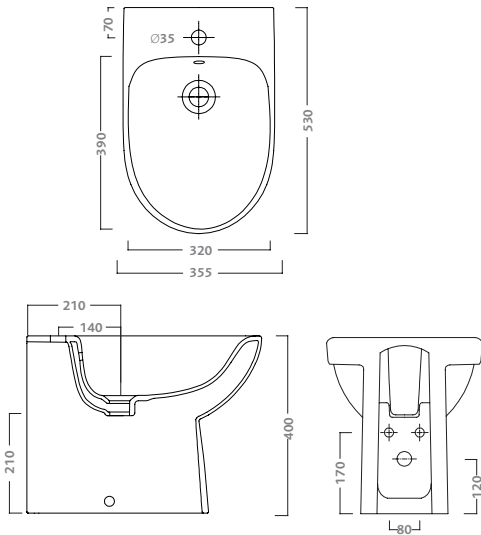

**bidet**  
 disponibile per rubinetteria monoforo.  
 per installazione filo parete. peso kg ca. 20  
 codice      descrizione  
 56251      bidet per installazione filo parete

**bidet**  
 available for one tap-hole. for back to wall  
 installation. weight 20 kg  
 code      description  
 56251      bidet for back to wall installation



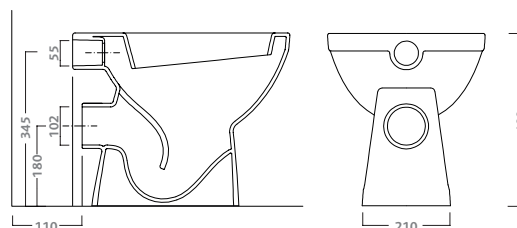
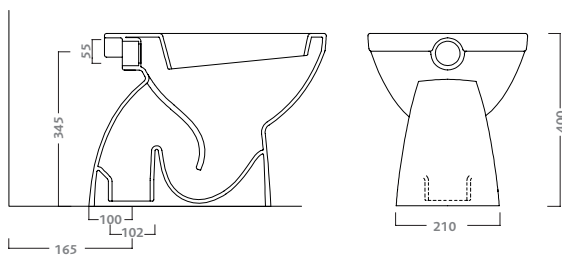
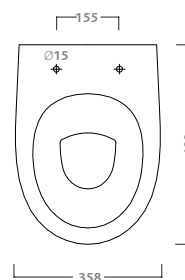
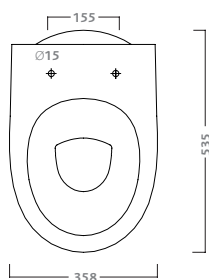

**vaso con scarico a pavimento**  
vaso a cacciata con scarico a pavimento (S).  
peso kg ca. 17. funziona con 4 litri.

codice	descrizione
58020	vaso con scarico a pavimento (S).
56764	sedile in termoindurente con cerniere in plastica.
56763	sedile in termoindurente con cerniere cromate.
56762	sedile in termoindurente con chiusura ammortizzata.

**vertical outlet water closet**  
vertical (V) outlet washdown bowl.  
weight 17 kg. 4 liters flushing.

code	description
58020	vertical (H) outlet water closet.
56764	duroplast seat with plastic hinges.
56763	duroplast seat with chrome-plated hinges.
56762	duroplast seat with soft close mechanism.

**vaso con scarico a parete**  
vaso a cacciata con scarico a parete (P). peso kg  
ca. 14.3. funziona con 4 litri

codice	descrizione
58021	vaso con scarico a parete (P).
56764	sedile in termoindurente con cerniere in plastica.
56763	sedile in termoindurente con cerniere cromate.
56762	sedile in termoindurente con chiusura ammortizzata.

**horizontal (H) water closet**  
horizontal (H) outlet washdown bowl. weight  
14.3 kg. 4 liters flushing.

code	description
58021	horizontal (H) outlet water closet.
56764	duroplast seat with plastic hinges.
56763	duroplast seat with chrome-plated hinges.
56762	duroplast seat with soft close mechanism.





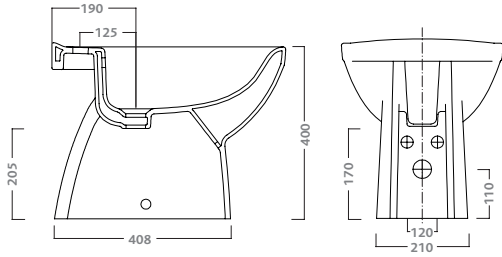
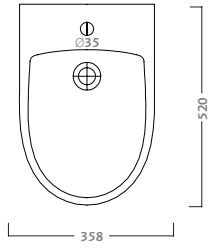

**bidet**  
 disponibile per rubinetteria monoforo.  
 peso kg ca. 16

codice	descrizione
58022	bidet

**bidet**  
 available for one tap-hole.  
 weight 16 kg

code	description
58022	bidet



# SELNOVA PRO

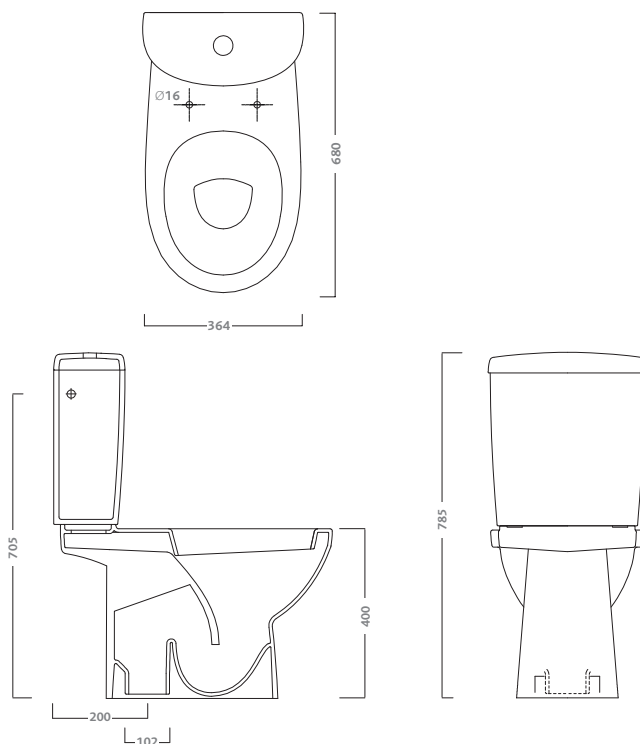

## vaso per cassetta

vaso a cacciata con scarico a pavimento (S).  
kit di fissaggio incluso. funziona con 4,5 litri.

codice	descrizione
58031	vaso per cassetta con scarico a pavimento (S). peso kg 17,6
58032	cassetta A.A./D.S completa di batteria. peso kg 11,8
58033	cassetta A.A./D.S. peso kg 10,8
56764	sedile in termoindurente con cerniere in plastica
56763	sedile in termoindurente con cerniere cromate
56762	sedile in termoindurente con chiusura ammortizzata

## water closet to be combined with cistern

vertical (V) outlet washdown bowl.  
fixing kit included. 4,5 liter flushing.

code	description
58031	vertical (V) outlet water closet to be combined with cistern. weight kg 17,6
58032	high water entry cistern with mechanism. weight 11,8
58033	high water entry cistern. weight 10,8
56764	duroplast seat with plastic hinges
56763	duroplast seat with chrome-plated hinges
56762	duroplast seat with soft close mechanism



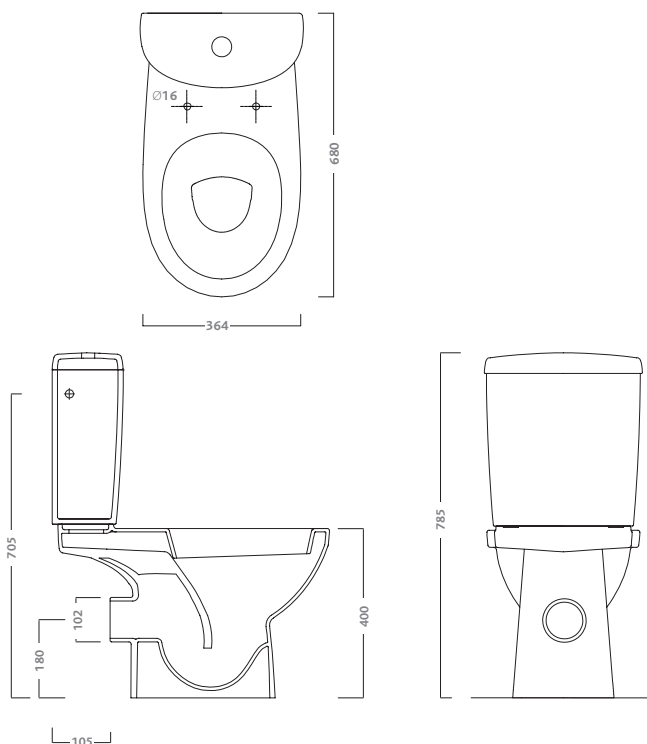

#### vaso per cassetta

vaso a cacciata con scarico a parete (P).  
kit di fissaggio incluso. funziona con 4,5 litri.

codice	descrizione
58030	vaso per cassetta con scarico a parete (P). peso kg 15,5
58032	cassetta A.A./D.S completa di batteria. peso kg 11,8
58033	cassetta A.A./D.S. peso kg 10,8
56764	edile in termoindurente con cerniere in plastica
56763	sedile in termoindurente con cerniere cromate
56762	sedile in termoindurente con chiusura ammortizzata

#### water closet to be combined with cistern

horizontal (H) outlet washdown bowl.  
fixing kit included. 4,5 liter flushing.

code	description
58030	horizontal (H) outlet water closet to be combined with cistern. weight 15,5
58032	high water entry cistern with mechanism. weight 11,8
58033	high water entry cistern. weight 10,8
56764	duroplast seat with plastic hinges
56763	duroplast seat with chrome-plated hinges
56762	duroplast seat with soft close mechanism



# SCELTE DIVERSE E VALORI GARANTITI

## VARIOUS CHOICES, GUARANTEED VALUES



**SELNOVA PRO** riformula la propria linea proponendo una serie di soluzioni, opzionali e standard, per dare valore aggiunto e personalizzare la scelta dell'ambiente bagno. il sedile del vaso viene proposto in abbinamento a tre diversi tipi di cerniere: in materiale plastico bianco (1), in acciaio cromato (2) e in acciaio cromato con chiusura ammortizzata soft close (3). i fissaggi dei sanitari sono nascosti in modo da rendere più pulite le caratteristiche estetiche ed igieniche. coniuga l'attenzione ecologica all'economia di casa il sistema di risciacquo con soli 4,5 litri d'acqua, lo standard per i vasi SELNOVA PRO, in perfetta combinazione con la cassetta Geberit Sigma8.

the SELNOVA PRO range is revamped with a series of optional or standard solutions to give added value and customised choice in the bathroom. toilet seats have a choice of three hinges: white plastic (1), chrome steel (2) and chrome steel with a soft-close mechanism (3). sanitaryware fixing bolts are hidden for a cleaner look and greater hygiene. a flush using only 4,5 litres of water combines eco-sustainability with domestic economy; it is the standard for SELNOVA PRO toilets, making a perfect team with the Geberit Sigma8 cistern.



**FRESH  
THINKING**

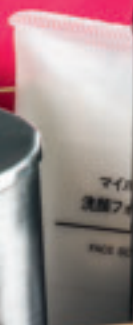

concept & styling  
simonasilenzistudio

photo  
gionata xerra

graphic design  
chiara boselli studio

styling e artbuying  
ilaria bacciocchi

photo assistant  
pierpaolo mazzola  
leonardo duggento

thanks to  
zucchetti. kos



Pozzi-Ginori è storia dell'arte e del design italiani della porcellana da bagno. Le sue origini risalgono al 1735, quando il marchese Carlo Ginori dette inizio, fra i primi in Europa, alla creazione di splendidi manufatti in quel prezioso tipo di ceramica che allora era chiamato "l'oro bianco". La sua Manifattura di Doccia, a nord ovest di Firenze, divenne presto fra le massime d'Europa. Nel tempo, con la Ginori si fusero le altre manifatture ceramiche progressivamente in Italia: prima quella di Giulio Richard, poi la Società Ceramica Italiana di Laveno, quindi la Pozzi. Ognuna di queste, prima da sola, poi integrandosi alle altre, ha segnato le varie tappe della sapienza e della tecnologia italiane nella progettazione e nella realizzazione di prodotti sanitari in porcellana. Con l'iniziare e poi l'affermarsi dei metodi e della prassi dell'industrial design, fin dal 1918 grandi designer hanno contribuito a scandire tali tappe: Giò Ponti, Guido Andlovitz, Studio Nizzoli, Le Corbusier, Giovanni Gariboldi, Antonia Campi, Gae Aulenti, Paolo Tilche, Matteo Thun e Antonio Citterio. Pozzi-Ginori entra in Sanitec nel 1993, e continua la sua grande tradizione con immutata costante capacità innovativa. Dal 2015 Pozzi-Ginori fa parte del Gruppo Geberit. Il Gruppo Geberit opera a livello globale ed è uno dei leader europei nel settore dei prodotti idrosanitari. Geberit opera come gruppo integrato con una forte presenza locale in molti paesi europei, fornendo un valore aggiunto unico quando si tratta di tecnologia e prodotti idrosanitari e ceramiche bagno.

Pozzi-Ginori represented the history of Italian art and design in bathroom ceramics. Its origins date to 1735, when Marquess Carlo Ginori was one of the first people in Europe to begin manufacturing splendid object in a precious grade of ceramics they used to call "white gold". His Doccia Factory northwest of Florence quickly became one of the largest in Europe. Over time, Ginori merged with other ceramic manufacturers that progressively sprang up in Italy: first, there was Giulio Richard, then the Laveno Italian Ceramic Company, and finally Pozzi. Each manufacturer began on its own, then merging with the other, as they established milestone in Italian technology and expertise in the design and creation of bathroom ceramic products. As the methods and practices of industrial design originated and then asserted themselves, great designers have helped articulate various stages since 1918: Giò Ponti, Guido Andlovitz, Studio Nizzoli, Le Corbusier, Giovanni Gariboldi, Antonia Campi, Gae Aulenti, Paolo Tilche, Matteo Thun and Antonio Citterio. After entering the Sanitec Group in 1993, Pozzi-Ginori has continued this grand tradition with its unchanging, constant copacity to innovate. From 2015 Pozzi-Ginori is part of the Geberit Group. The globally operating Geberit Group is a European leader in the field of sanitary products. Geberit operates as an integrated group with a very strong local presence in most European countries, providing unique added value when it comes to sanitary technology and bathroom ceramics.

I dati e le caratteristiche indicate non impegnano la Geberit Marketing e Distribuzione SA che si riserva il diritto di apportare delle modifiche ritenute opportune senza obbligo di preavviso e sostituzione.

The data and characteristics indicated in this catalogue do not bind Geberit Marketing e Distribuzione SA, which reserves the right to make the necessary modifications without notice or product replacement.



Geberit Marketing e Distribuzione SA  
Via Gerre 4  
CH-6928 Manno/Svizzera  
T +41 91 611 92 92  
F +41 91 611 93 93  
[www.pozzi-ginori.it](http://www.pozzi-ginori.it)